

- Low Noise: $12 \mu\text{g}/\sqrt{\text{Hz}}$ typical for 5g Full Scale Version
- -55 to +175°C Operation
- Responds to frequencies from zero (DC) to 2000+ Hz
- High Stability and Durability
- $\pm 4\text{V}$ Differential Output
- +5 VDC, 5 mA Power (Typical)
- Integrated Sensor & Amplifier
- Internal Temperature Sensor
- Nitrogen Damped & Hermetically Sealed
- Serialized for Traceability
- RoHS Compliant



AVAILABLE G-RANGES

FULL SCALE ACCELERATION	20 PIN JLCC
$\pm 5 \text{ g}$	1531J-005
$\pm 10 \text{ g}$	1531J-010
$\pm 25 \text{ g}$	1531J-025
$\pm 50 \text{ g}$	1531J-050
$\pm 100 \text{ g}$	1531J-100
$\pm 200 \text{ g}$	1531J-200
$\pm 400 \text{ g}$	1531J-400

The Model 1531 is a low-cost, general-purpose integrated MEMS accelerometer for use in zero to medium frequency industrial applications that require extremely low noise and reliable long-term stability in high-temperature environments. The Model 1531 accelerometers are individually tested, programmed, calibrated and verified in a climate chamber to ensure the greatest accuracy in even high temperature conditions.

Each miniature, hermetically sealed package combines a MEMS capacitive sense element and a custom integrated circuit that includes a sense amplifier and differential output stage. Each device is marked with a serial number on its top and bottom surfaces for traceability. A calibration test report (1531-TST) is provided with every unit showing the measured bias, scale factor, linearity, operating current, & frequency response.

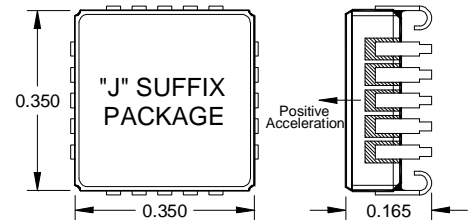

ZERO (DC) TO MEDIUM FREQUENCY APPLICATIONS



PERFORMANCE

INPUT RANGE	SENSITIVITY, DIFFERENTIAL	FREQUENCY RESPONSE (TYPICAL, 5%)	FREQUENCY RESPONSE (TYPICAL, 3 DB)	FREQUENCY RESPONSE (MINIMUM, 3 DB)	OUTPUT NOISE, DIFFERENTIAL (RMS, TYPICAL)	MAX. MECHANICAL SHOCK (0.1 MS)
g	mV/g	Hz	Hz	Hz	$\mu\text{g}/(\text{root Hz})$	g (peak)
± 5	800	0 – 400	0 – 800	0 – 420	12	5000
± 10	400	0 – 700	0 – 1100	0 – 660	18	
± 25	160	0 – 1300	0 – 1750	0 – 1050	25	
± 50	80	0 – 1600	0 – 2100	0 – 1400	50	
± 100	40	0 – 1700	0 – 3000	0 – 1700	100	
± 200	20	0 – 1900	0 – 3600	0 – 2100	200	
± 400	10	0 – 2000	0 – 4200	0 – 2400	400	

By Model: $V_{DD}=V_R=5.0 \text{ VDC}$, $T_C=25^\circ\text{C}$

Single ended sensitivity is half of values shown.

SPECIFICATIONS SUBJECT TO CHANGE WITHOUT NOTICE

PERFORMANCE - ALL VERSIONS

All Models: Unless otherwise specified $V_{DD}=V_R=5.0$ VDC, $T_C=25^\circ\text{C}$, Differential. Span = $\pm g$ range = 8000 mV

PARAMETER	MIN	TYP	MAX	UNITS
Bias Calibration Error (mV)		16	40	\pm mV
Bias Calibration Error (Span)		0.2	0.5	\pm % of span
Bias Temperature Shift ($T_C= -55$ to $+125^\circ\text{C}$) ¹	-200	0	+200	(PPM of span)/ $^\circ\text{C}$
Scale Factor Calibration Error ²		0.5	1	\pm %
Scale Factor Temperature Shift ($T_C= -55$ to $+125^\circ\text{C}$) ¹	-200	0	+200	PPM/ $^\circ\text{C}$
Non-Linearity (-90 to +90% of Full Scale) ^{1,2}		0.15	0.5	\pm % of span
Long Term Bias Stability		1000	2000	\pm PPM of span
Long Term Scale Factor Stability		500	1000	\pm PPM
Cross Axis Sensitivity		2	3	\pm %
Input Axis Misalignment		5	10	\pm mrad
Turn-On Transient (in less than 0.5ms)		75		\pm PPM of FS
Output Impedance		90		Ohms
Operating Voltage ³	4.75	5.0	5.25	volts
Operating Current (IDD+IVR)		5.5	6.5	mA
Mass		0.68		grams
Case Operating Temperature	-55 to +175 $^\circ\text{C}$	Voltage on V_{DD} to GND		-0.5V to 6.0V
Storage Temperature	-55 to +175 $^\circ\text{C}$	Voltage on any Pin (except DV) to GND ³		-0.5V to $V_{DD}+0.5V$
Max Reflow Solder Temperature	+239 $^\circ\text{C}$	Voltage on DV to GND (Self-Test)		$\pm 15V$
Power Dissipation		50 mW		

Note 1: Tighter tolerances are available on other SDI accelerometers.

Note 2: For 5g thru 50g only; 100g and greater versions are tested and specified from -65 to +65g.

Note 3: Voltages on pins other than DV, GND or V_{DD} may exceed 0.50 volt above or below the supply voltages provided the current is limited to 1 mA.

NOTICE: Minimize exposure above 155 $^\circ\text{C}$ for maximum lifespan. Stresses greater than those listed above may cause permanent damage to the device. These are maximum stress ratings only. Functional operation of the device at or above these conditions is not implied. Exposure to absolute maximum rating conditions for extended periods may affect device reliability and lifespan.

OPERATION

The Model 1531 produces a differential output voltage of ± 4 volts full scale, the value of which varies with acceleration as shown in the figure below. The sensitive axis is perpendicular to the bottom of the package, with positive acceleration resulting from a positive force pushing on the bottom of the package. The seismic center is located on a centerline through the dual sense elements and halfway between them. The internal electronics effectively cancel any errors due to rotation. Two reference voltages, +5.0 and +2.5 volts (nominal), are required; scale factor is ratiometric to the +5.0 volt reference voltage relative to GND, and both outputs at zero acceleration are nominally the same as the +2.5 volt input.

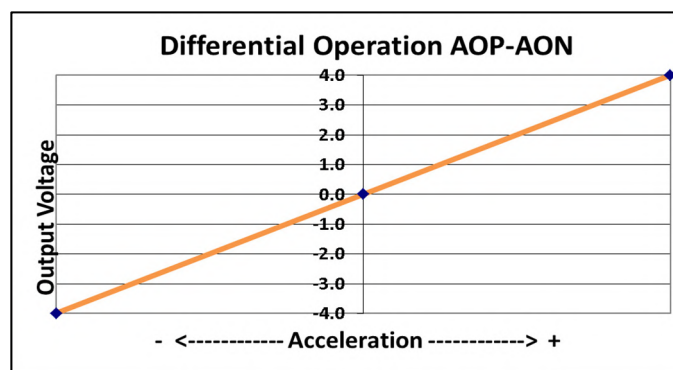

SPECIFICATIONS SUBJECT TO CHANGE WITHOUT NOTICE

SIGNAL DESCRIPTIONS

V_{DD} and GND (power): Pins (14) and (19) respectively. Power (+5 Volts DC) and ground.

AOP and AON (output): Pins 12 and 16 respectively. Analog output voltages proportional to acceleration. The AOP voltage increases (AON decreases) with positive acceleration; at zero acceleration both outputs are nominally equal to the +2.5 volt reference. The device experiences positive (+1g) acceleration with its lid facing up in the earth's gravitational field. Use of differential mode is strongly recommended for both lowest noise and highest accuracy operation. Voltages can be measured ratio-metrically to VR for good repeatability without requiring a separate precision reference voltage for an A/D.

DV (input): Pin 4. Deflection Voltage. Connect to the 2.5 Volt pin for best repeatability. A test input that applies an electrostatic force to the sense element, simulating a positive acceleration. The nominal voltage at this pin is $\frac{1}{2} V_{DD}$. DV voltages higher than required to bring the output to positive full scale may cause device damage to 5g and 10g devices.

VR (input): Pin 3. Voltage Reference. Tie to a good reference (not directly to VDD) for best scale factor repeatability. A 0.1µF bypass capacitor is recommended at this pin. The current is less than 100 µA.

2.5 Volt (input): Pin 17. Sets internal and output common mode value. Tie to a resistive voltage divider from +5 volts. A 0.1µF bypass capacitor is recommended at this pin. The current is less than 50 µA.

I_T (output): Pin 8. Temperature dependent current source. May be tied to V_{DD} or left disconnected if not used.

Special Use Pins: Pins 9 and 11 should be tied to VDD, Pins 2, 5, 6, and 18 to GND.

*** Pins 1, 7, 10, 13, 15, and 20 are reserved for future use and should remain unused ***

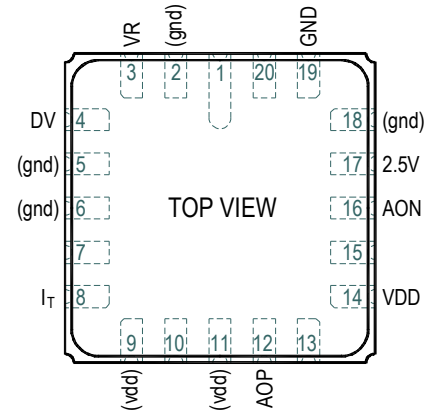

RECOMMENDED CONNECTIONS

DEFLECTION VOLTAGE (DV) TEST

INPUT: This test input applies an electrostatic force to the sense element, simulating a positive acceleration of up to +10g. It has a nominal input impedance of 32 kΩ and a nominal open circuit voltage of $\frac{1}{2} V_{DD}$. For best accuracy during normal operation, this input should be left unconnected or connected to a voltage source equal to $\frac{1}{2}$ of the V_{DD} supply.

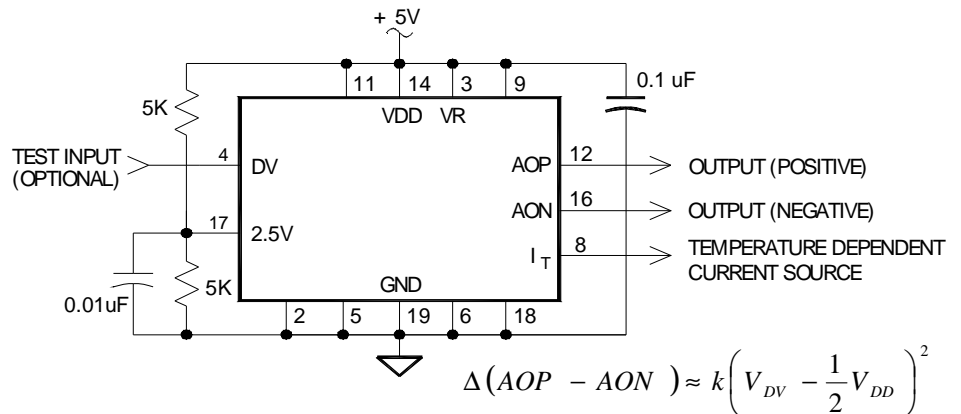

The change in differential output voltage (AOP - AON) is proportional to the square of the difference between the voltage applied to the DV input (V_{DV}) and $\frac{1}{2} V_{DD}$. Only positive shifts in the output voltage may be generated by applying voltage to the DV input. When voltage is applied to the DV input on 5g or 10g devices, it should be applied gradually to avoid damage. The application of DV voltages greater than required to bring the output to positive full scale may cause device damage. The proportionality constant (k) varies for each device and is not characterized.

ESD and LATCH-UP CONSIDERATIONS: The model 1531 accelerometer is a CMOS device subject to damage from large electrostatic discharges. Diode protection is provided on the inputs and outputs, and it is not easily damaged, but care should be exercised during handling. However, individuals and tools should be grounded before coming in contact with the device. Although the 1531 is resistant to latch-up, inserting a 1531 into or removing it from a powered socket may cause damage.

OPTIONAL INTERNAL TEMPERATURE SENSING

The model 1531 accelerometer contains a temperature dependent current source that is output on pin 8. This signal is useful for measuring the internal temperature of the accelerometer so that any previously characterized bias and scale factor temperature dependence, for a particular accelerometer, can be corrected.

The nominal output current at 25°C is $\approx 500 (\pm 200) \mu\text{A}$ and the nominal sensitivity is $1.5 (\pm 0.5) \mu\text{A}/^\circ\text{C}$. Fluctuations in V_{DD} & V_{R} have little effect on the temperature reading. A reduction of 0.10 V to both V_{DD} & V_{R} will reduce the current about $1 \mu\text{A}$, which corresponds to less than a 1°C change in reading. With a single resistor $R_{\text{T}} = 2\text{K}$ between I_{T} (pin 8) and GND the output voltage V_{T} will vary between +0.76 and +1.3 volts from -55 to $+125^\circ\text{C}$, which equates to a sensitivity of $\approx 3 \text{ mV}/^\circ\text{C}$.

If a greater voltage change versus temperature or lower signal source impedance is needed, add the amplifier as shown on the right side in Figure 2. With offset voltage $V_{\text{OFF}} = -5\text{V}$, gain resistor $R_{\text{G}} = 15.0\text{K}$ and offset resistor $R_{\text{OFF}} = 7.32\text{K}$, the output voltage V_{T} will vary between +4.5 and +0.5 Volts from -55 to $+125^\circ\text{C}$, which equates to a sensitivity of $\approx -29 \text{ mV}/^\circ\text{C}$.

Figure 3 shows the voltage compliance of the temperature dependent current source (I_{T}) at room temperature. The voltage at pin 8 must be kept in the 0 to +3V range in order to achieve proper temperature readings.

$$V_{\text{T}} \approx R_{\text{T}} [(500 \mu\text{A}) + [(1.5 \mu\text{A})(T - 25)]]$$

$$\frac{\Delta V_{\text{T}}}{\Delta T} = R_{\text{T}} (1.5 \mu\text{A})$$

$$V_{\text{T}} \approx -R_{\text{G}} \left[\frac{V_{\text{OFF}}}{R_{\text{OFF}}} + (500 \mu\text{A}) + [(1.5 \mu\text{A})(T - 25)] \right]$$

$$R_{\text{OFF}} = \frac{-V_{\text{OFF}}}{\left(\frac{V_{\text{T}}}{R_{\text{G}}} \right) + (500 \mu\text{A}) + [(1.5 \mu\text{A})(T - 25)]}$$

$$R_{\text{G}} = \frac{-\Delta V_{\text{T}}}{(1.5 \mu\text{A})(\Delta T)} \quad \frac{\Delta V}{\Delta T} = -R_{\text{G}} (1.5 \mu\text{A})$$

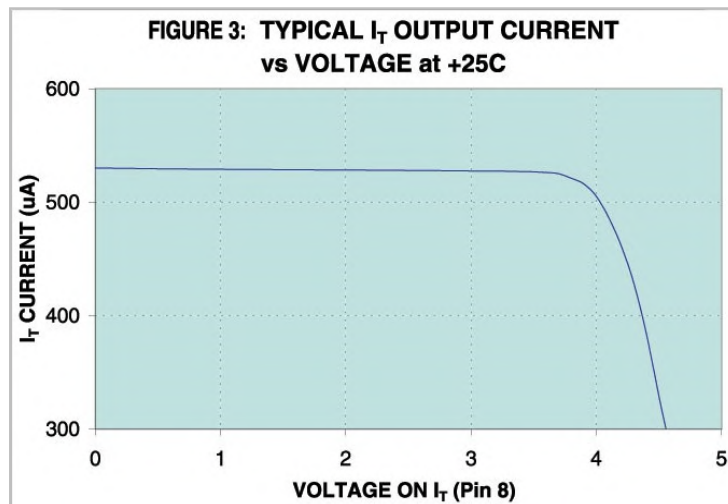
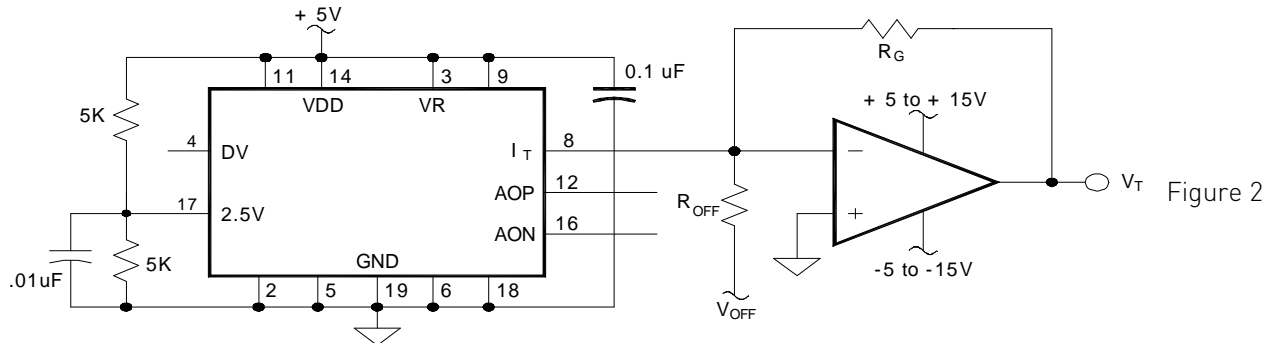

SPECIFICATIONS SUBJECT TO CHANGE WITHOUT NOTICE

PACKAGE DIMENSIONS

1. *Dimensions "M," "T," and "U" locate sensing element's center of mass.
2. Lid is electrically tied to terminal 19 (GND).
3. Controlling dimension: Inch.
4. Terminals are plated with 60 micro inches min gold over 80 micro inches min nickel. This plating specification does not apply to the Pin-1 identifier mark on the bottom of the J-lead package version.
5. Package: 90% min alumina (black), lid: solder sealed kovar.

Dim	Inches		Millimeters	
	Min	Max	Min	Max
A	0.342	0.358	8.69	9.09
B	0.346	0.378	8.79	9.60
D	0.095	0.115	2.41	2.92
F	0.050 BSC		1.27 BSC	
K	0.010 R TYP		0.25 R TYP	
* M	0.066 TYP		1.68 TYP	
N	0.050	0.070	1.27	1.78
P	0.017 TYP		0.43 TYP	
R	0.023 R TYP		0.58 R TYP	
* T	0.085 TYP		2.16 TYP	
* U	0.175 TYP		4.45 TYP	

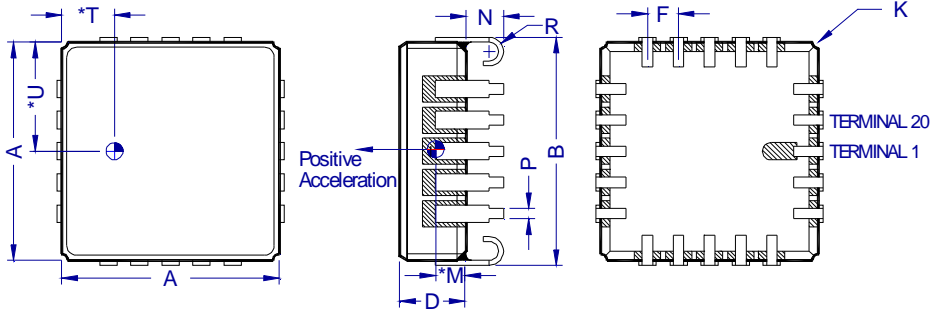

SOLDERING RECOMMENDATIONS

RoHS Compliance: The model 1531 does not contain elemental lead and is RoHS compliant.

Soldering: Solder reflow should not exceed 239°C, exceeding this temperature may result in permanent damage.

Pre-Tinning of Accelerometer Leads is Recommended: To prevent gold migration embrittlement of the solder joints, it is best to pre-tin the accelerometer leads.

LCC Solder Contact Plating Information: The plating composition and thickness for the solder pads and castellations on the J-Lead package top layer is 100 to 225 microinches thick of 99.7% gold (Au) over 80 to 350 microinches thick of electroplated nickel (Ni).

Recommended Solder Pad Pattern: The recommended solder pad size and shape for the J-Lead packages is shown in the diagram and table. These dimensions are recommendations only and may or may not be optimum for your particular soldering process.

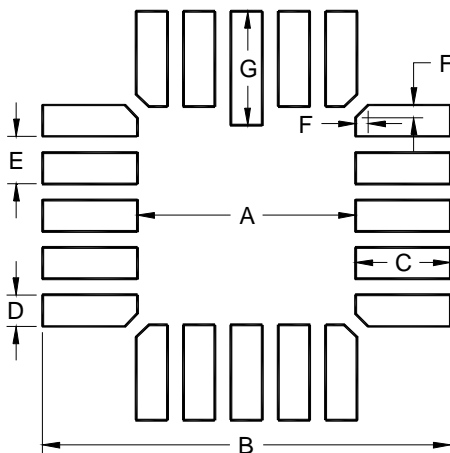

*Do not use ultrasonic cleaners.
Ultrasonic cleaning may break internal wire bonds and will void the warranty.*

DIM	Inch	mm
A	.230	5.84
B	.430	10.92
C	.100	2.54
D	.033	0.84
E	.050	1.27
F	.013	0.33
G	.120	3.05

SPECIFICATIONS SUBJECT TO CHANGE WITHOUT NOTICE

**TEST REPORT EXAMPLES:
LINEARITY, PHASE & FREQUENCY RESPONSE BY G-LEVEL**

The included 1531-TST calibration test reports provide additional information about the linearity, output, phase, and frequency response as tested for each individual unit. The following are examples of the graphical data supplied on test reports, by G-level.

NOTE: Frequency response on test reports is documented by simulating frequency response with the DV pin. This will indicate lower values than the actual performance once soldered or otherwise permanently installed upon a board.

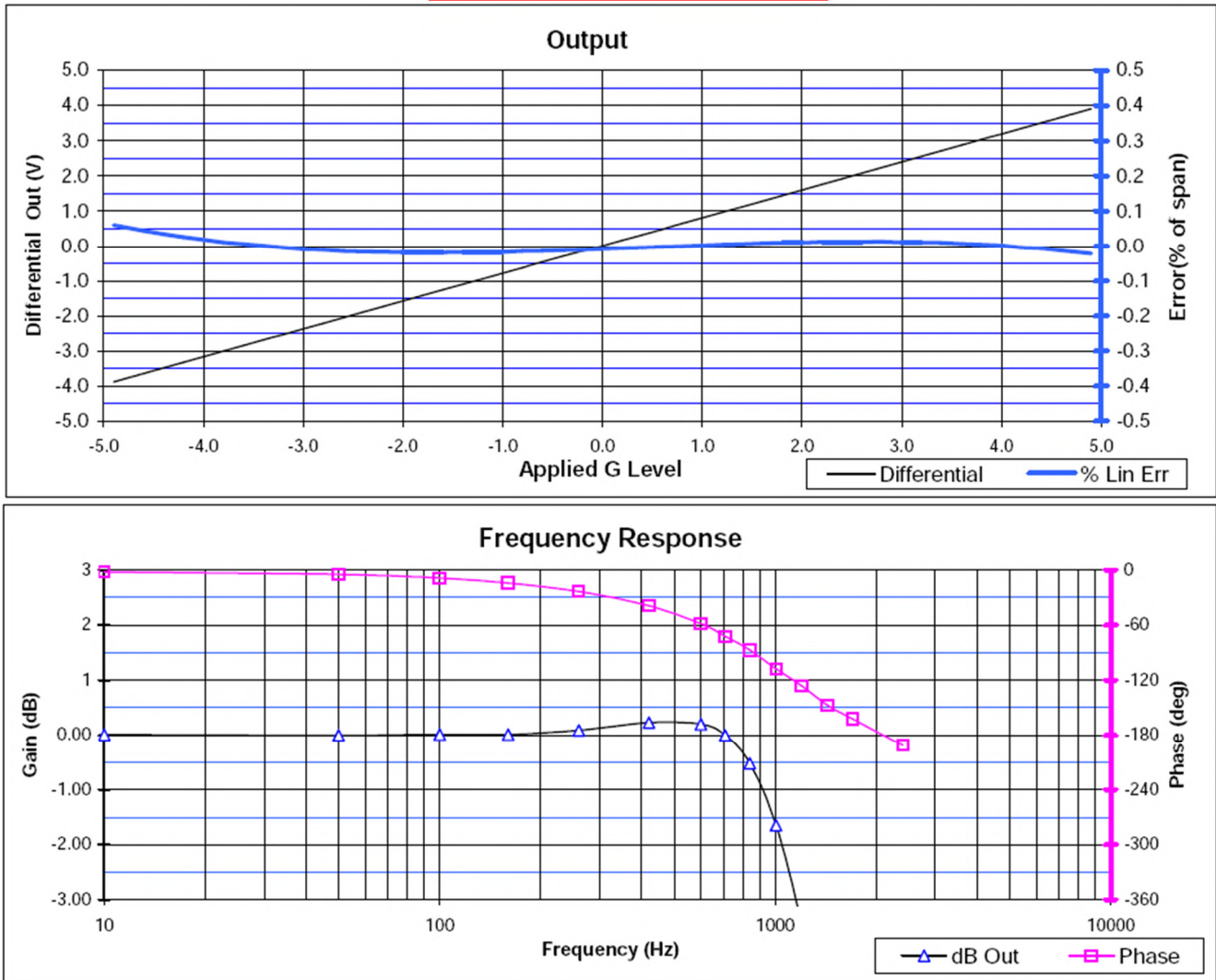
EXAMPLE 5G: 1531L-005

SPECIFICATIONS SUBJECT TO CHANGE WITHOUT NOTICE

EXAMPLE 10G: 1531L-010

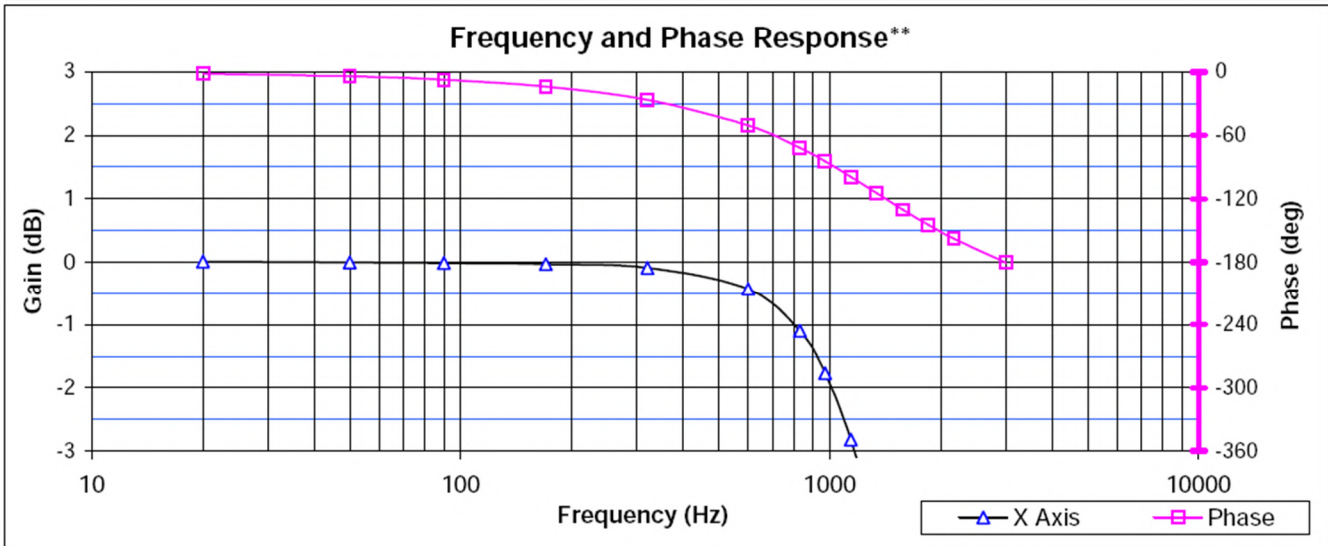
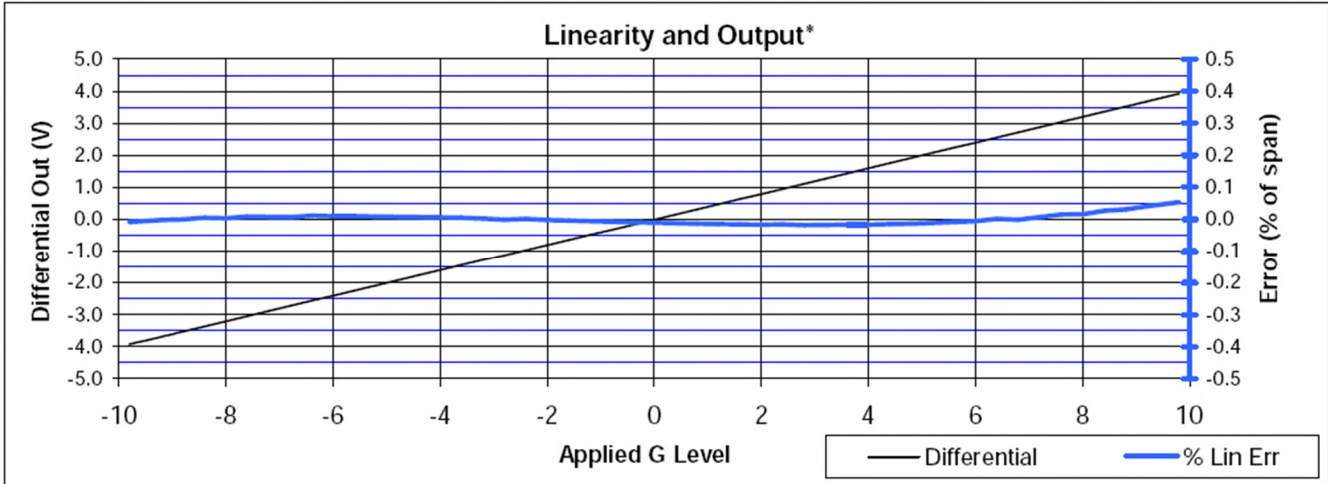

SPECIFICATIONS SUBJECT TO CHANGE WITHOUT NOTICE

EXAMPLE 25G: 1531L-025

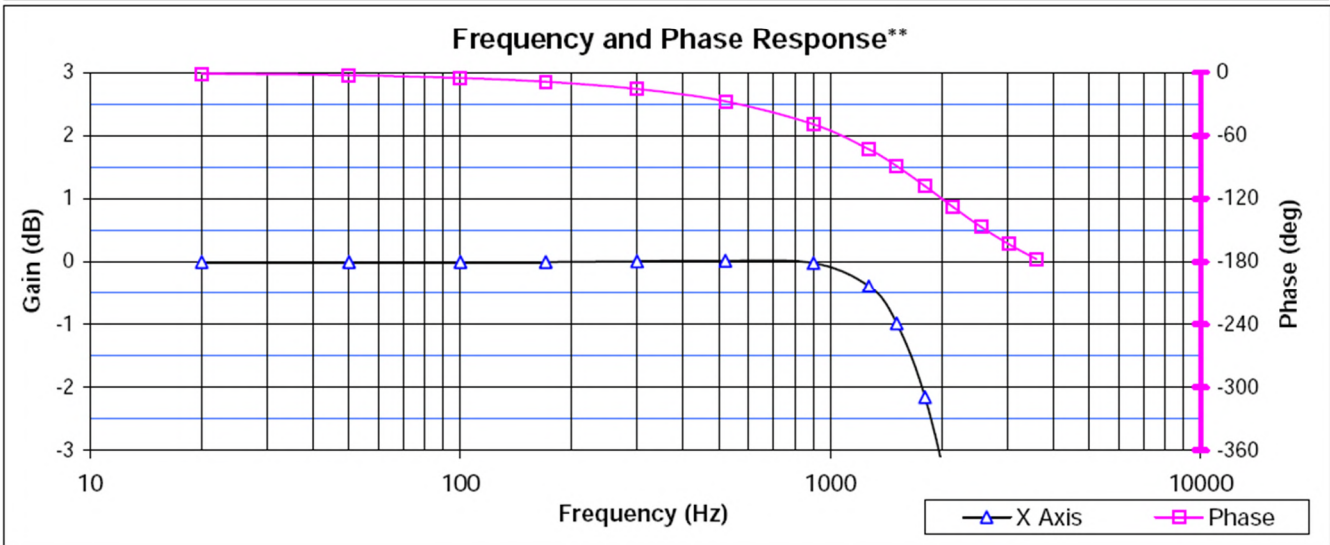
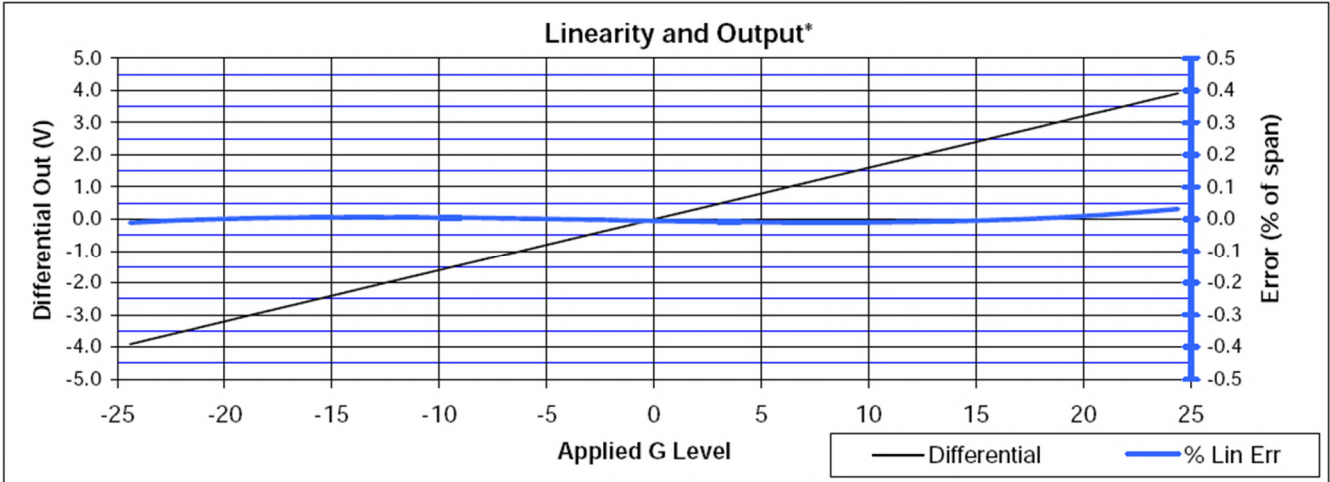

SPECIFICATIONS SUBJECT TO CHANGE WITHOUT NOTICE

EXAMPLE 50G: 1531L-050

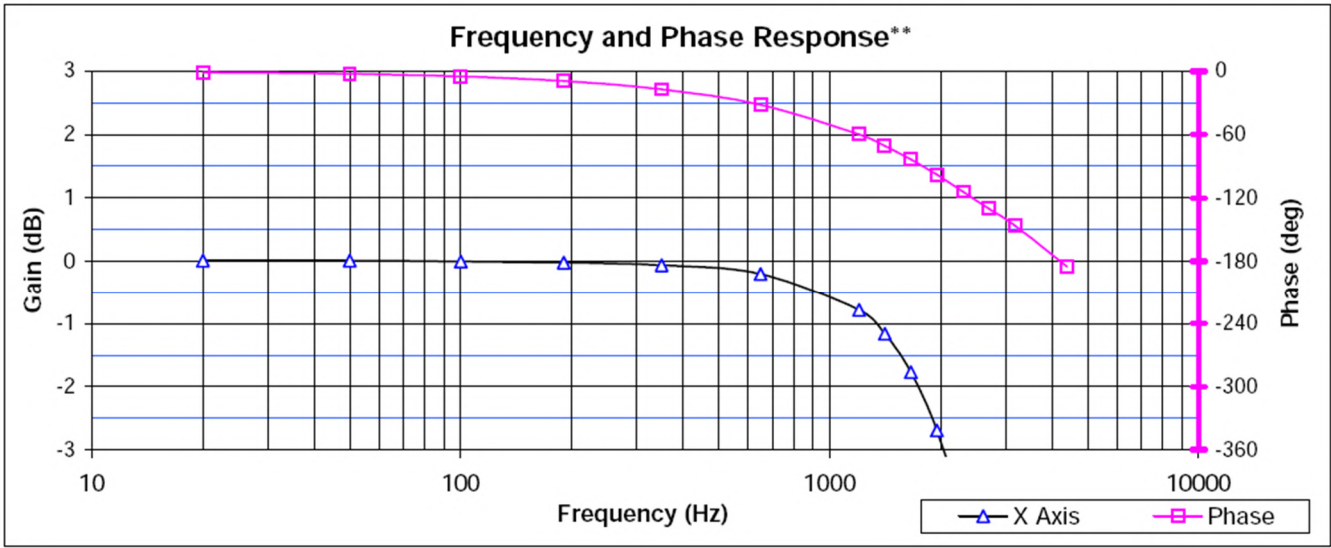
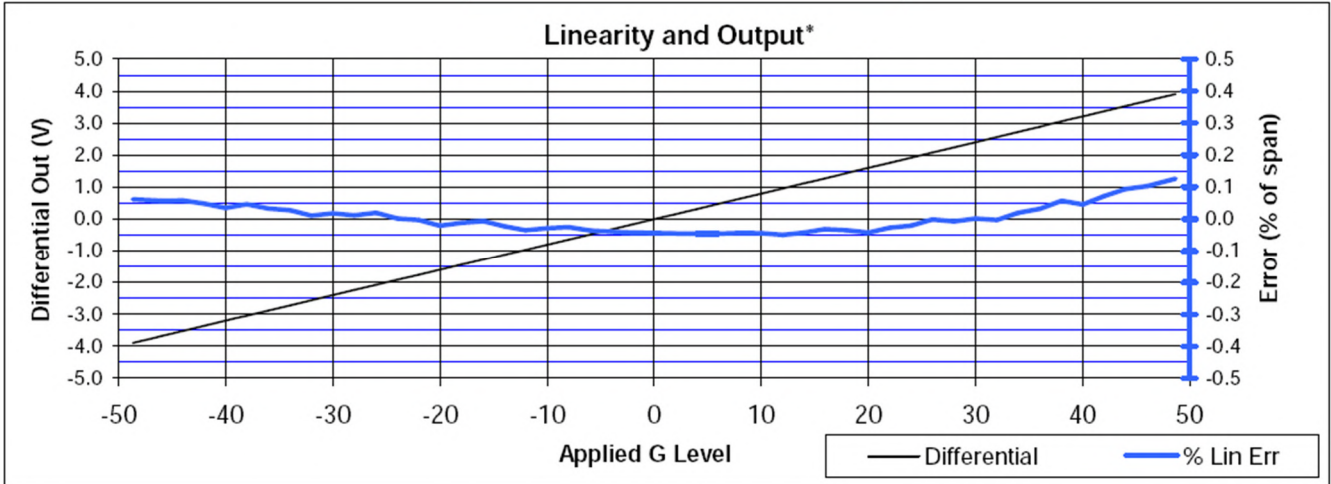

SPECIFICATIONS SUBJECT TO CHANGE WITHOUT NOTICE

EXAMPLE 100G: 1531L-100

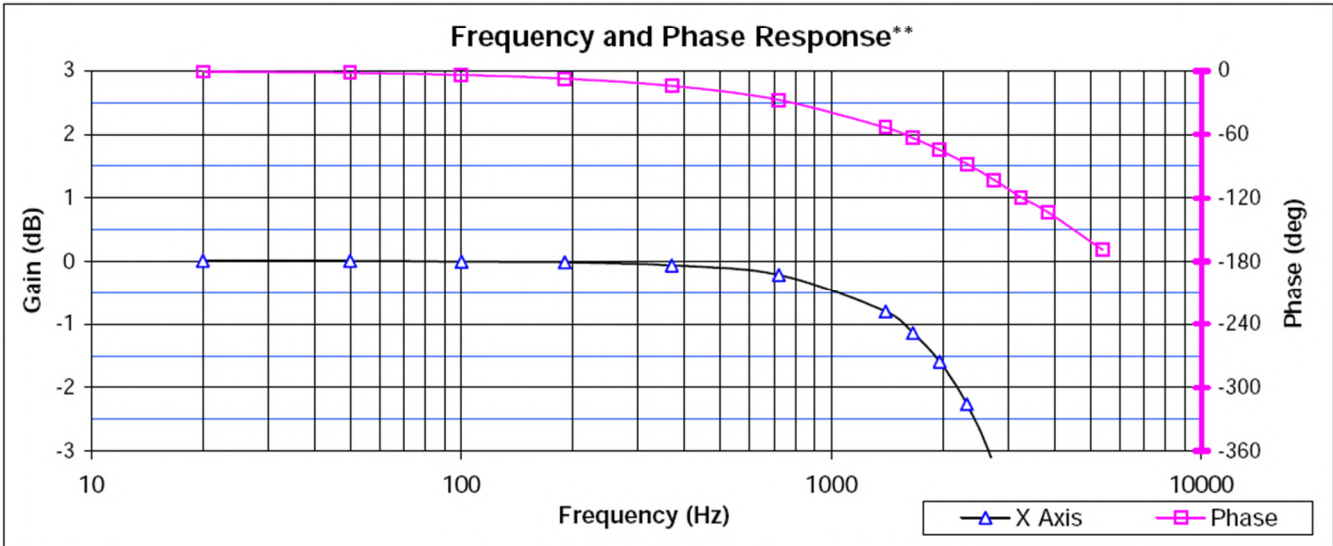
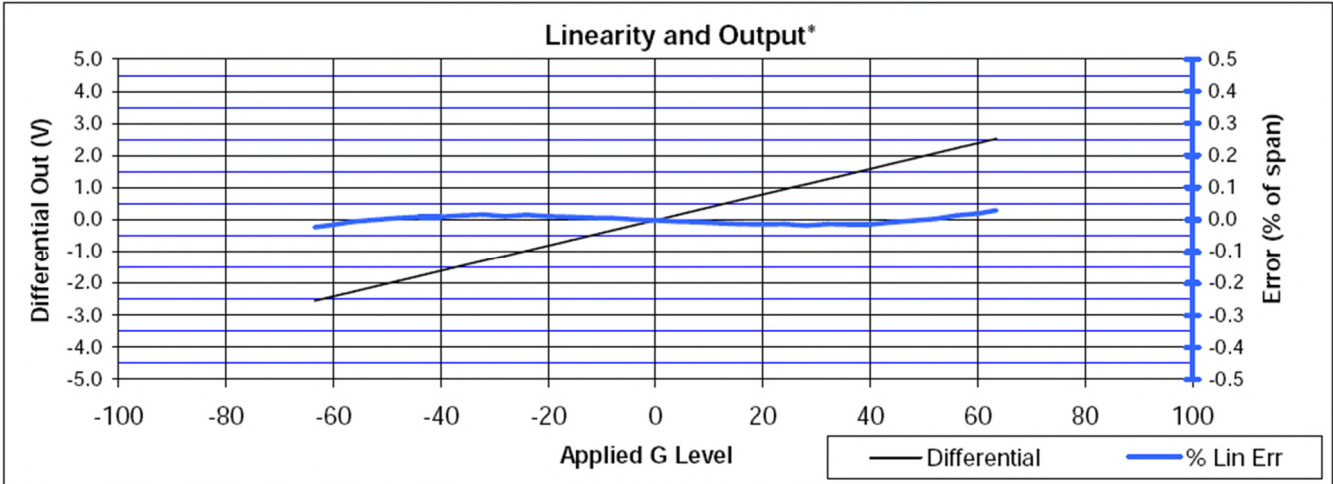

SPECIFICATIONS SUBJECT TO CHANGE WITHOUT NOTICE

EXAMPLE 200G: 1531L-200

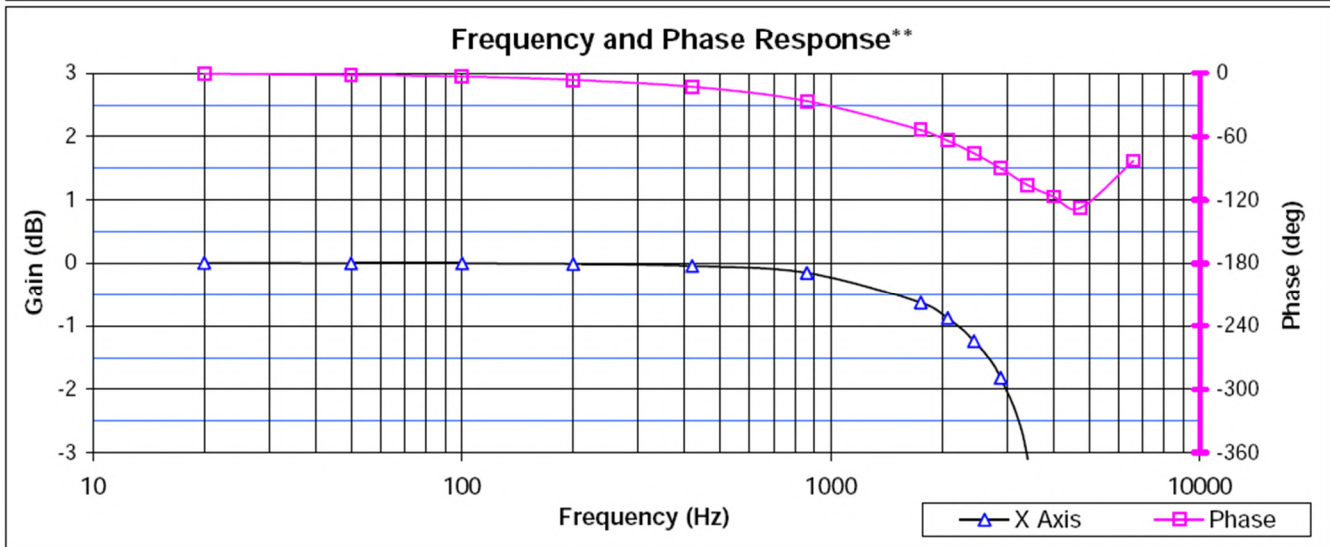
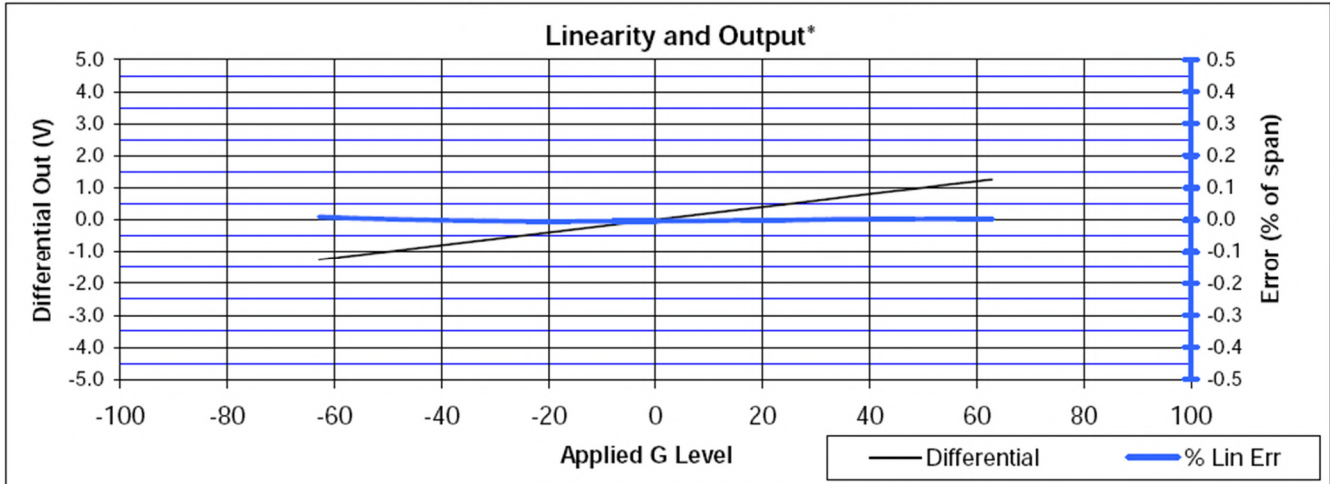

SPECIFICATIONS SUBJECT TO CHANGE WITHOUT NOTICE

EXAMPLE 400G: 1531L-400

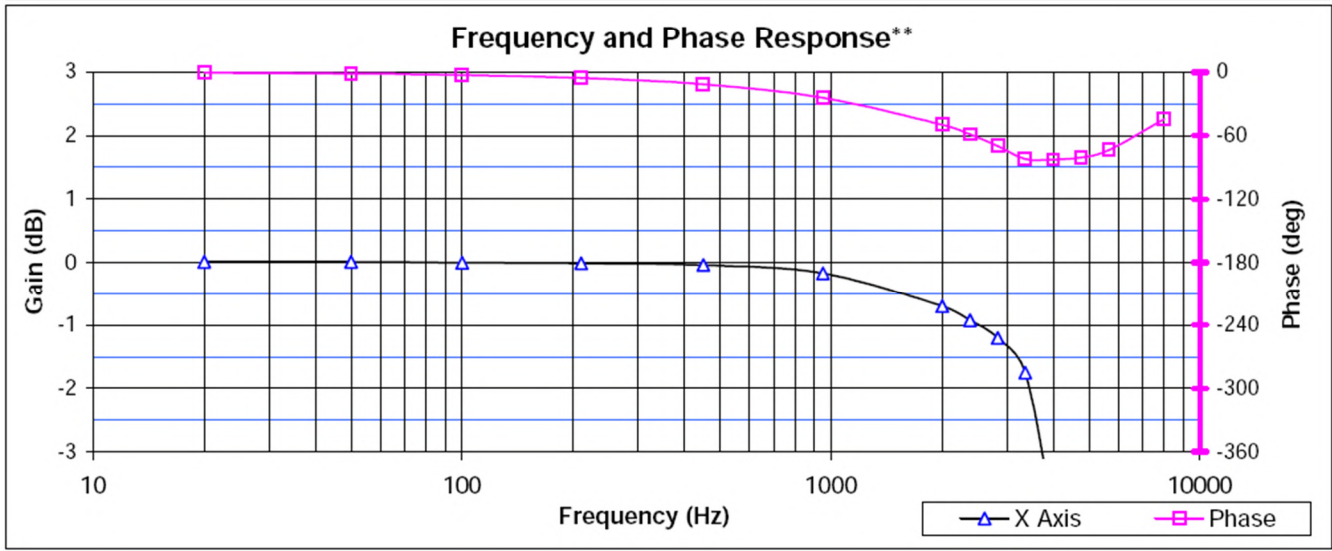
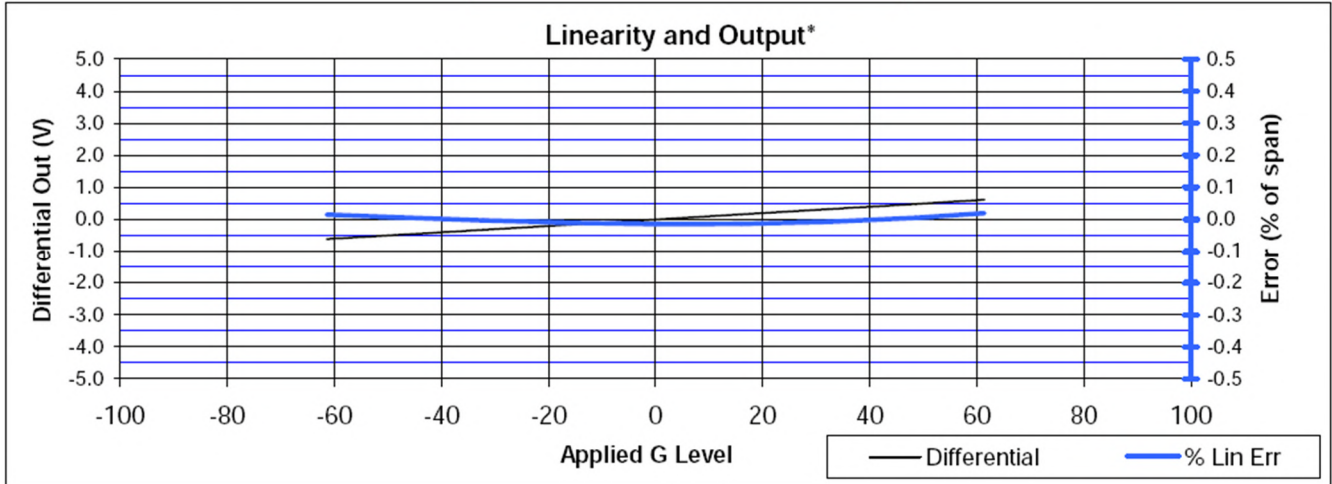

COMPANION ACCESSORY

The Model EB-J Analog Test Sets provide a convenient means of testing and evaluating SDI Model 1531 surface mount accelerometers in the JLCC package formats. The zero-insertion-force socket is pre-fitted to the board, which includes set jumpers for advanced features of SDI accelerometers. A 10-pin connector and ribbon cable provide connections to the user's test equipment. The EB-J Sets and SDI Surface Mount Accelerometers are each sold separately.

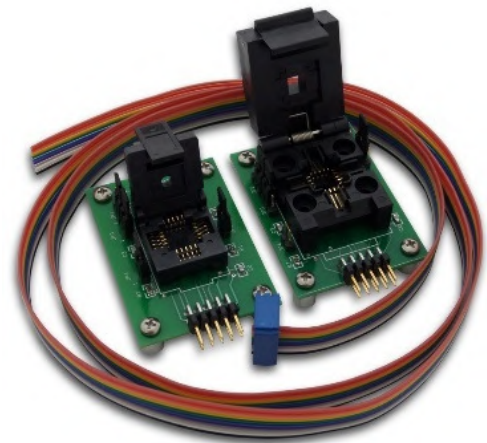

SPECIFICATIONS SUBJECT TO CHANGE WITHOUT NOTICE